

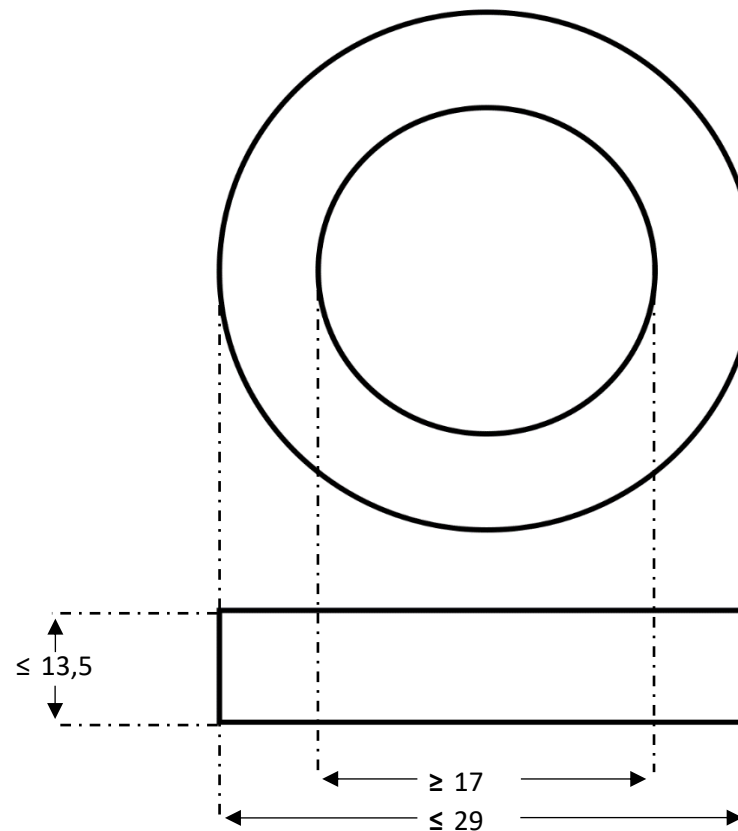

Product		Core Material	Core Dimensions	Case Dimensions	Weight in gram	Packaging
D0025R04N01-02		Nanocrystalline	25x20x10 mm	29x17x13,5 mm	11	450 pcs. pr. box
Housing		Permeability	Frequency	H_{peak}	L_{Fe}	A_{Fe}
Cased	Round	4000	10 kHz	3 mA/cm	7,1 cm	0,2 cm ²



Values in mm

Inspection Values	Measurement limits	Frequency	$I_{eff} \times N$ (mA turns)	Date: 23.04.2024	 Blueferrite.com
AL (μH)	1,0 - 2,0	10 kHz	100	Index: 2 Revision: 1	
AL (μH)	1,0 - NA	100 kHz	100	Comments:	
Created	Approved	Released	Quality	Product released	
MWE	MMO	HJP/MMO	HJP	All parameters can be changed without prior notice.	